

# Energy-Efficient Filtration of Smoke and Odours



KMA exhaust air filtration systems for the food processing industry

- Environmentally friendly
- Energy-efficient
- Cost-saving



## Separates smoke and odours highly efficiently, saves energy, reduces CO<sub>2</sub>!

**Energy consumption and CO<sub>2</sub> emissions generated by production processes are examined in the course of all discussions related to climate change. The modular KMA exhaust air filtration systems reduce energy demand up to 80 percent for waste air purification. And thus protect the environment.**

### The most important factor for industrial environmental protection: Efficiency

KMA produces exhaust air filtration systems for several ranges of industrial applications. During the development period our engineers and process technicians focus consistently on sustainability and energy-efficiency. As a result, the KMA exhaust air filters consume up to 80 percent less energy compared to conventional post combustion systems!

**Less energy consumption leads to low costs!**

*Consequently KMA exhaust air filtration systems have a relatively short payback period due to the reduced energy costs.*

KMA Umwelttechnik stands for quality and innovation. More than 2,500 installed filtration systems worldwide provide evidence of this. Their usage achieves sustained success by avoiding environmental pollution such as smoke and odour. At the same time they make an important contribution to climate protection due to minimum energy consumption.

### Main applications:

- Frying lines/continuous frying systems
- All kind of smokehouses (e.g. meat, fish)
- Baking facilities and baking ovens
- Roasting plants for coffee/cacao/nuts
- Large-scale catering establishments, canning factories
- Livestock breeding and fattening facilities

The degree of efficiency is crucial!



The Greek letter Eta (η) symbolises the effectiveness and the degree of efficiency for the utilisation of energy. Efficient environmental protection in any industry is the consistently used synergetic effect between the maximum degree of efficiency and the minimal energy input.

**“ KMA waste air purification is effective and efficient in environmental protection! ”**

## Clean air by KMA!

### ■ Your contribution to climate protection

The carbon footprint is a relatively recent concept in the global environmental debate. It describes the total amount of carbon dioxide (CO<sub>2</sub>) emissions, caused and released by production processes. Industrialised countries have committed to reduce CO<sub>2</sub> emissions by at least 20 percent by the year 2020.

The result: in all areas of our society large efforts are being made in order to prepare new laws and regulations. But alongside headline-grabbing discussions such as those about electric cars or energy-saving light bulbs, many other profound changes occur in silence. In a wide range of industries, entire production processes are being modified or replaced by more energy-efficient technologies.

This change is posing a challenge for all companies. Whoever ignores this development is taking the risk of being shut out of the market as avoidable CO<sub>2</sub> emissions can cause high additional costs. Therefore it is time to put one's own production facilities under close scrutiny.

The KMA exhaust air filtration systems for food processing industry do not only purify the air from smoke and odours, they additionally – thanks to an energy-saving operation – reduce CO<sub>2</sub> emissions significantly.

### By the way:

*The development of KMA AAIRMAXX<sup>®</sup> was supported by the German Environment Foundation and awarded with the DLG FoodTec Award.*

*The KMA ULTRAVENT<sup>®</sup> hybridfilter was awarded with the Innovation Award 2011 of the Volksbank Bonn Rhein-Sieg.*



# KMA exhaust air filtration systems

*modular, flexible and economical*



## The energy-saving KMA filter modules separate smoke, dust, grease, tar and odours at manufacturing facilities

*Many production processes in the food processing industry create a waste air composite made of smoke and impurities resulting in odour. KMA exhaust air filtration systems allow the highly efficient separation of emissions and thus provide a solution to any problem created by waste air in the food processing industry. Adhesive substances can easily be removed by the automatic filter cleaning system.*



### ■ Electrostatic precipitator

KMA electrostatic filters assure the highly effective separation of aerosols such as grease, tar (smoke) or oil mist from waste air, without plugging the filter material and become ineffective.

The AAIRMAXX<sup>®</sup> electrostatic precipitator is made of one metal tube and an ioniser in the middle. The waste air is charged by electrostatic energy, which makes the particles settle on the inner surface of the tube.

The ULTRAVENT<sup>®</sup> electrostatic filter cell operates on the same principle, but is characterised by a different structure: the filter cells consist of several juxtaposed collection plates.

#### Applies to both:

No filter replacement is required. KMA electrostatic filters are an economical and durable filter medium for many applications

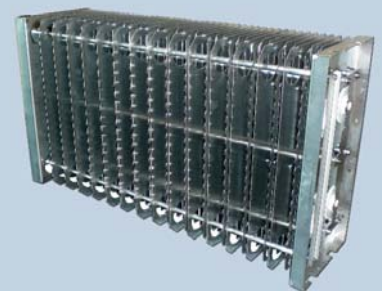

### ■ Biofilter

The biofilter from the KMA modular system is designed to separate low concentrated odours and gases from large waste air volumes.

Operating with a biofilter is cost-effective, particularly for constant exhaust air flows. Odours are separated by biochemical oxidation reaction for pollutants with the usage of microorganisms. The reaction products are CO<sub>2</sub> and water.



## ■ Gas Scrubber

The KMA scrubber is designed for the separation of odour, gas and fumes. It operates on the principle of absorption. Gases and fumes contained in the exhaust air are bounded and deposited by the use of a suitable washing liquid. Main characteristics of KMA scrubbers are high separation efficiency and low water consumption. Furthermore, the scrubber can be used as a humidifier before the treatment of waste air by a biofilter.



## ■ UV Light

With ultraviolet light many intensely smelling VOC molecules (e.g. from frying lines) can be oxidised. The result is a significant improvement in odour. In many cases, bad smells are completely eliminated. UV light needs, just like activated carbon, a good pre-filtration of dust or smoke in order to achieve full and long-term effectiveness. A reaction section, following the UV-oxidation stage, is always required to complete the oxidation process.

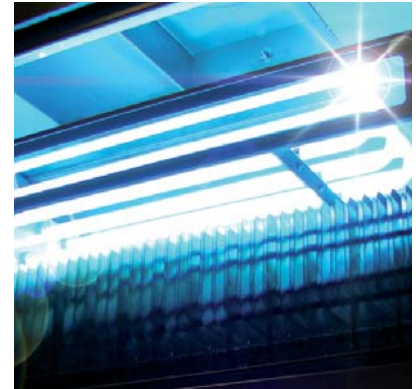

## ■ Activated Carbon Filter

Activated carbon and activated lignite effectively adsorb many different kinds of smoke and odours. They are considered to be universal filters for odour removal in the food processing industry. Odorous substances and air molecules deposit on the surface of the activated lignite. For an economic operation a good pre-treatment of the exhaust air is necessary: aerosols and dust have to be separated before the carbon filtration treatment.



## ■ Heat Recovery System

Exhaust air purification combined with heat exchangers enable heat recovery of process heat. At low exhaust air temperatures the heat recovery system can be optimised by the integration of a highly efficient KMA Ambitherm<sup>®</sup> heat pump. The heat recovered from the exhaust air can be used for heating process water or the manufacturing halls. Because of the close installation of the heat exchanger to the filter zone, it can be regularly washed at the same time as the filter module by the automatic cleaning system.



**KMA exhaust air filtration systems are characterised by following features:**

- *high air quality by highly efficient filtration components*
- *cost-effective operation through wear-resistant filters and low energy consumption*
- *minimised maintenance due to highly effective automatic filter cleaning*
- *adaptable as decentralised or centralised filter*
- *flexibility through a modular system with many different sizes*
- *durability: filter housing and collection cells are made from stainless steel on request*



## Active environmental protection, which pays off!

*KMA filtration systems – highly efficient cleaning of exhaust air while saving energy and costs*

In the food processing industry the largest potential to avoid CO<sub>2</sub> emissions, apart from refrigeration technology, lies within exhaust air filtration technology. Conventional catalytic or thermal post-combustion systems require large amounts of oil, gas or electricity to purify exhaust air. High energy consumption is accompanied by a corresponding amount of CO<sub>2</sub> emissions.

### **KMA provides an energy efficient solution to the problem:**

With the AAIRMAXX<sup>®</sup> modular filter system and the ULTRAVENT<sup>®</sup> hybrid filter, KMA offers two exhaust air filtration systems, which connect high air quality with economy and eco-efficiency and which are adaptable to any food processing facility.

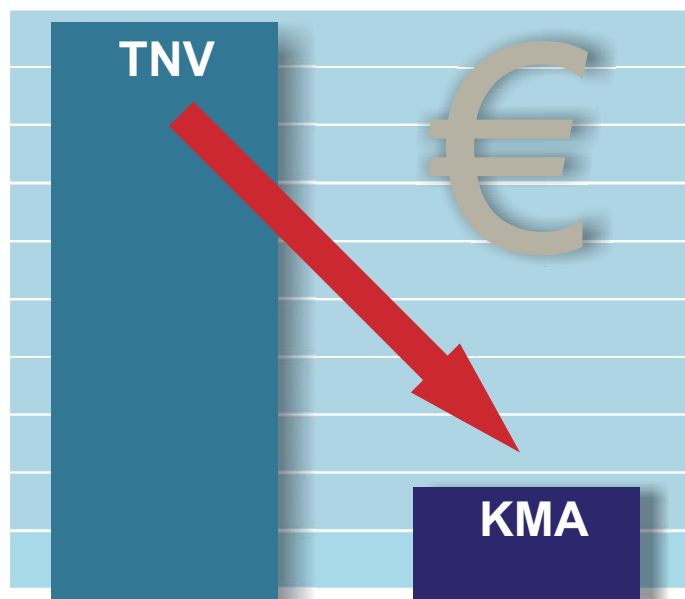

“ Replace your post-combustion system and save money!



Ask us for a free operation cost comparison adapted to your specific application. KMA exhaust air filtration systems purify the air and reduce your natural gas consumption at the same time!

You will save energy, reduce the consumption of natural resources and preserve the global climate.

This is active environmental protection!

# KMA filtration systems in action



■ Fig. left:

A smokehouse with 4 smoke chambers is equipped with a central KMA AAIRMAXX<sup>®</sup> filtration system, consisting of an electrostatic precipitator and a gas scrubber.



■ Fig. right:

To purify the exhaust air of several tunnel fryers with a total air volume of 12,000 m<sup>3</sup>/h (greasy smoke and odour), an AAIRMAXX<sup>®</sup> filtration system is used. The filtration system consists of air-to-air heat exchangers, scrubber and biofilter.



■ Fig. right:

The horizontal KMA activated carbon filters are used in restaurant operations and catering kitchens. The carbon filtration cells are regenerative with granulate activated carbon.



■ Fig. left:

For large-scale plants (more than 1,500 m<sup>3</sup>/h capacity) a container version for outdoor installations are available.





**The modular KMA exhaust air filtration systems can be used for all applications in the food processing industry. The variety of applications is shown in the following examples.**

## **KMA AAIRMAXX® for smokehouses**

A post-combustion system with a capacity of 1,500 m<sup>3</sup>/h (which is about a smokehouse with 6 to 8 smoke chambers) requires even with a modern heat recovery system more than 40 m<sup>3</sup> of natural gas per hour. This is not only expensive but also leads to CO<sub>2</sub> emissions of nearly 80 kg per hour. The consequence: even with an annual usage of 1,500 hours (which is equivalent to 6 hours of daily smoking time) the operator will face an energy consumption of more than 60,000 m<sup>3</sup> for natural gases. Thus, about 120 tons of CO<sub>2</sub> emissions are generated!

At this point, in many smokehouses an enormous potential for reducing costs and CO<sub>2</sub> emissions can be found.

### **Fig. below:**

AAIRMAXX® filter system equipped by an electrostatic precipitator (right), gas scrubber (left) and fan (center). The separated tar is collected in the blue waste barrel.

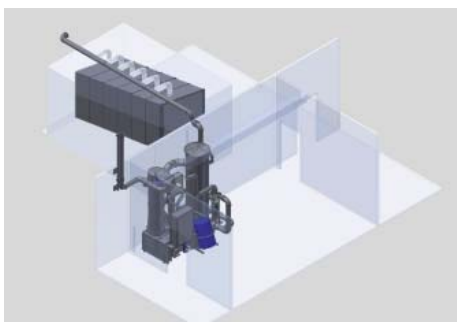

### **Fig. above:**

The drawing shows the filter system and 6 connected smokehouses.

### **The solution:**

*By replacing an old air treatment device with an energy-efficient AAIRMAXX® filtration system, the energy demand can be decreased up to more than 80 percent. This is accompanied by a significant reduction of CO<sub>2</sub> emissions. In our example mentioned before, the annual reduction of CO<sub>2</sub> emissions is over 100 tons!*

*According to the energy savings the expenditure for the new filtration system is amortised in less than 3 years.*

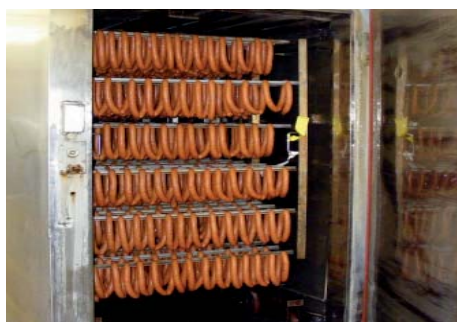

## **Fish food production plant**

Fish food production processes cause strongly odorous exhaust air. Post-treatment by a post-combustion is non-economical because of the large amount of exhaust air.

### **The solution:**

*To avoid neighborhood nuisance the exhaust air (25,000 m<sup>3</sup>/h) is purified by an AAIRMAXX® exhaust air filtration system. The filtration system consists of gas scrubber and activated carbon filter. The regulation of the pH-value and the water exchange take place automatically. The activated carbon filter is composed of two towers with 12,500 m<sup>3</sup>/h capacity each. Due to the high pre-separation during the first step of filtration, the replacement of the carbon filter units occur at long intervals.*





## KMA ULTRAVENT<sup>®</sup> hybrid filter for industrial frying plants

The ULTRAVENT<sup>®</sup> hybrid filter with highly efficient heat recovery system and UV light for odour abatement is particularly suitable for connecting to industrial frying lines.

Again, the KMA filter system is an energy-efficient alternative to after-burning systems. A practical example shows how big the savings are: A customer was planning a significant expansion of its capacity of fryers.

At the same time the operation was seeking to produce more energy-efficient and to meet the environmental objectives of management.

### The solution:

*With the expansion of capacity the company replaced its old post-combustion system with an air volume of 5,000 m<sup>3</sup>/h by a new KMA hybrid filter with an exhaust air capacity of 25,000 m<sup>3</sup>/h.*

*While the old post-combustion system generated annually more than 1,000 tons of carbon dioxide, the new exhaust air filtration system decreased the CO<sub>2</sub> emissions down to 115 tons per year, by purifying a five times bigger amount of exhaust air capacity.*

*Thus, the company achieved its goal to sustainably reduce the carbon footprint with a single remedial action. The annual savings in operation costs led to a payback period of less than 2 years!*

The high level of eco-efficiency is caused by the interaction of several energy-efficient components:

- Energy-saving electrostatic precipitator
- UV light for odour abatement
- Highly efficient heat recovery system, consisting of heat exchangers and heat pump

CO<sub>2</sub> reduction  
**900 t**

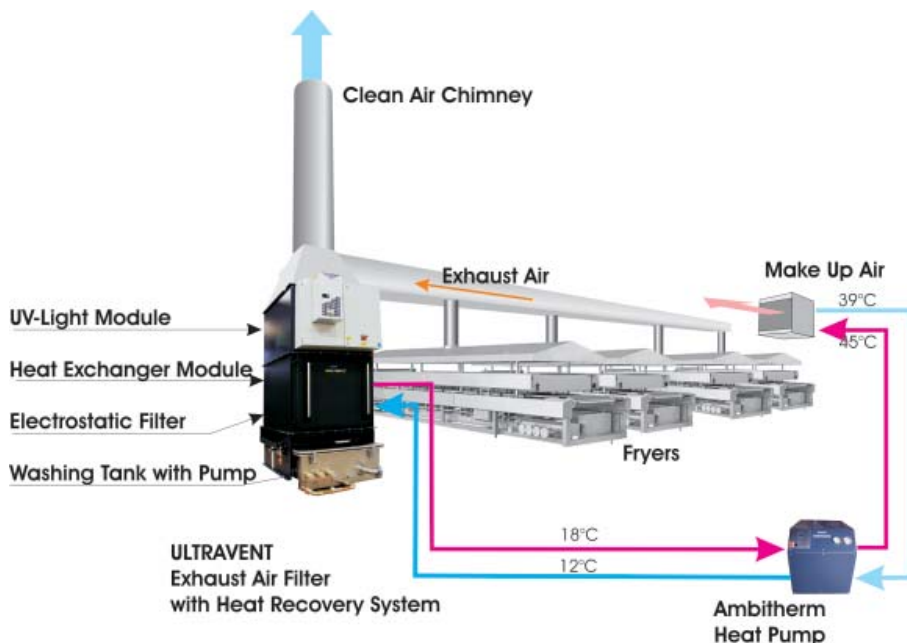

Here again:

By replacing the post-combustion system by an energy-efficient ULTRAVENT<sup>®</sup> hybrid filter, the energy consumption is reduced significantly. This is accompanied by a significant reduction of CO<sub>2</sub> emissions.

In our example the company reduced their CO<sub>2</sub> emissions by nearly 900 tons per year!



## Benefits at a glance

*Point for point a benefit!*

**Through innovative ideas KMA exhaust air filtration systems combine several advantages - our designers have thought of everything.**

### ✓ **KMA exhaust air filtration systems fit to any production process!**

Whether you fry, roast, bake, smoke or dry: KMA AAIRMAXX® and KMA ULTRAVENT® deal with any waste air problem and remain free in the choice of the production method.

### ✓ **Rehabilitate old plants with KMA exhaust air filters**

KMA exhaust air filtration systems have no adverse effect on processes, which take place during the production process. Existing production systems can be used without further modification and meet after the installation of a KMA exhaust air filter, the provisions of the Federal Pollution Control Act (BImSchG). Benefit: The existing food products remain 100 percent the same in their production technique as well as their taste.

### ✓ **The operation costs of KMA exhaust air filtration systems are particularly low!**

KMA exhaust air filters use the most advantaged and cost-effective method of exhaust air purification by combining electrostatic precipitators with other energy-efficient modular elements (e.g. scrubber or UV light for odour abatement). Here the energy costs are decreased up to 80 percent compared to conventional post-combustion systems.

### ✓ **High filtration efficiency**

KMA exhaust air filtration systems ensure compliance with the emission limit values according to TA-Luft (Technical Instructions on Air Quality Control) and the VDI-guidelines.

### ✓ **Almost wear-free operation**

KMA exhaust air filtration systems are not subject to thermal wear. By using highly efficient electrostatic precipitators no filter replacement is necessary. Evidence of this is demonstrated by more than 2,500 systems installed in many companies, some with more than 50,000 hours of operational experience.

#### Did you know?

KMA exhaust air filtration systems allow centralised or decentralised extraction concepts. Which solution makes more sense in individual cases depends mainly on factors within the company: e.g. the amount of exhaust air, the space and the distance between the individual process units.

For a decentralised extraction no installation of complex exhaust air ducts is required. The centralised concept waives the multiple execution of individual module elements: e.g. a central filtration system requires only the integration of a single automatic cleaning system.

#### Decentralised and centralised extraction concepts

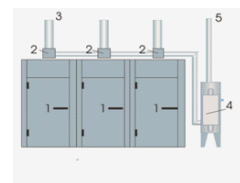
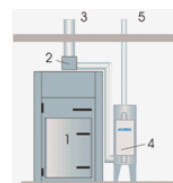

1. Smokehouse(s)
2. Damper
3. Exhaust air for drying

4. KMA Filter
5. Purified air chimney

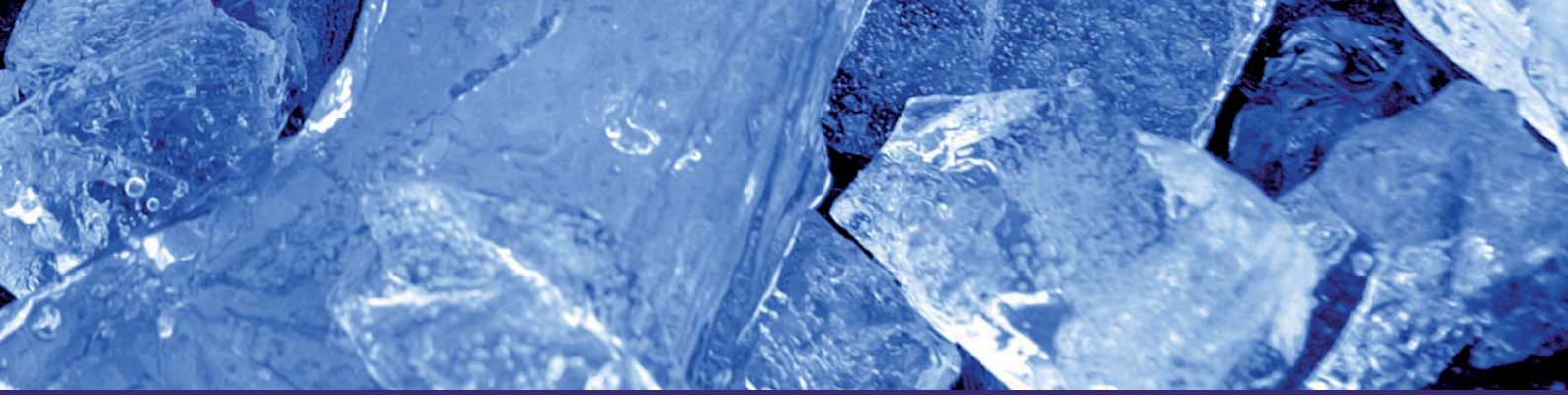

## KMA – your reliable partner for energy-efficient filter technology

*Our environment is our future!*

*We look forward to share our expertise with you and inform you about our innovations.*

### What can we do for you?

We are happy to provide you, free of charge, with a proposal for a system configuration which is exactly adapted to your needs. Using comprehensive equipment descriptions and detailed operating cost comparisons, we develop an economically optimal solution for you.

### Our service package includes:

- Consulting
- Applications concerning environmental legislation
- Delivery of complete air filtration systems
- Service

Give us a call, send us a message or visit us on our website.

We look forward to your request.

**Phone: +49 (0) 2244 - 9248 0**

**info@kma-filter.de**

**www.kma-filter.de**

### KMA filter – committed to the environment

The company KMA is characterised by people who, above all, are convinced that producing energy-efficient air purification systems makes an active contribution to the protection of the environment and reduces the greenhouse effect. This is in all of our interests; and will benefit future generations.

**Protecting the environment while saving energy and costs.**

**No problem with KMA emission control systems.**





## **KMA Umwelttechnik GmbH**

Eduard-Rhein-Str. 2  
53639 Koenigswinter  
Germany

Phone: +49 2244 9248-0  
Fax: +49 2244 9248-30

[info@kma-filter.de](mailto:info@kma-filter.de)

[www.kma-filter.de](http://www.kma-filter.de)

